

Article number: 20475B10B8ELS

Description: E+G Two-way clamp mounting - GN 475-B10-B8-ELS

Measures

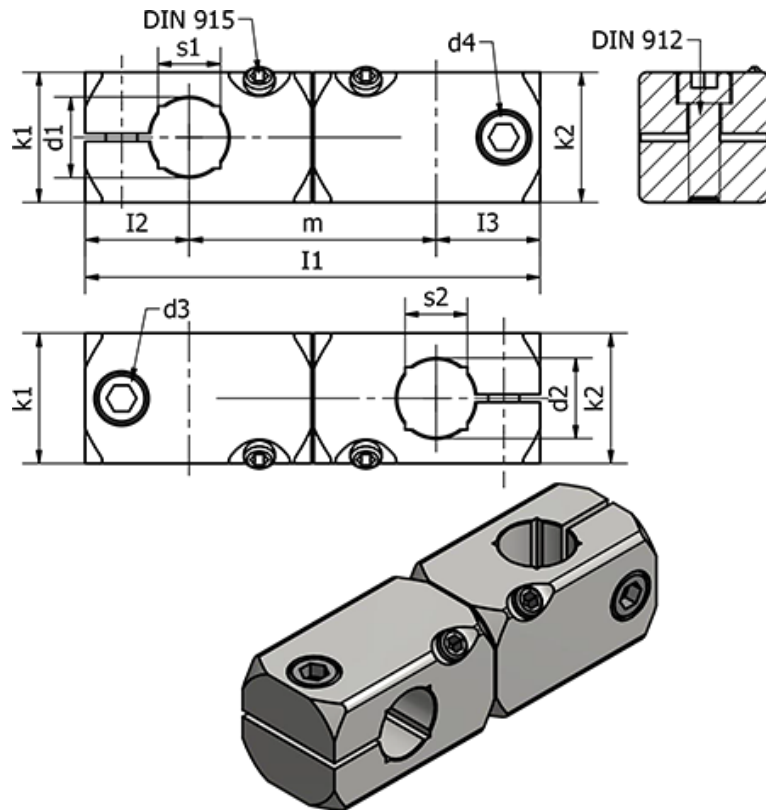

Clamping kit for d3 = GN 511-M5-20

Clamping kit for d4 = GN 511-M4-16

d1 = 10

d2 = 8

d3 = M5

d4 = M4

I1 = 58

I2 = 15.5

I3 = 13

k = 20

k2 = 16

m = 29.5

s1 = 8

s2 = -

Weight (g) = 40